

SCALE: 1/4" = 1' WHEN PRINTED ON 11x17 PAPER

BASED ON THE INTERNATIONAL RESIDENTIAL CODE

STAIRWAY ILLUMINATION: ALL EXTERIOR STAIRWAYS SHALL BE ILLUMINATED AT THE TOP LANDING TO THE STAIRWAY. ILLUMINATION SHALL BE CONTROLLED FROM INSIDE THE DWELLING OR AUTOMATICALLY ACTIVATED.

DISCLAIMER: THIS PLAN IS NOT CONSIDERED COMPLETE UNLESS APPROVED BY YOUR LOCAL BUILDING INSPECTOR OR STRUCTURAL ENGINEER. BUILDER ACCEPTS ALL RESPONSIBILITY AND LIABILITY. DECKS.COM LLC, AND ASSOCIATED SPONSORS ACCEPT NO LIABILITY FOR THE USE OF THIS PLAN.

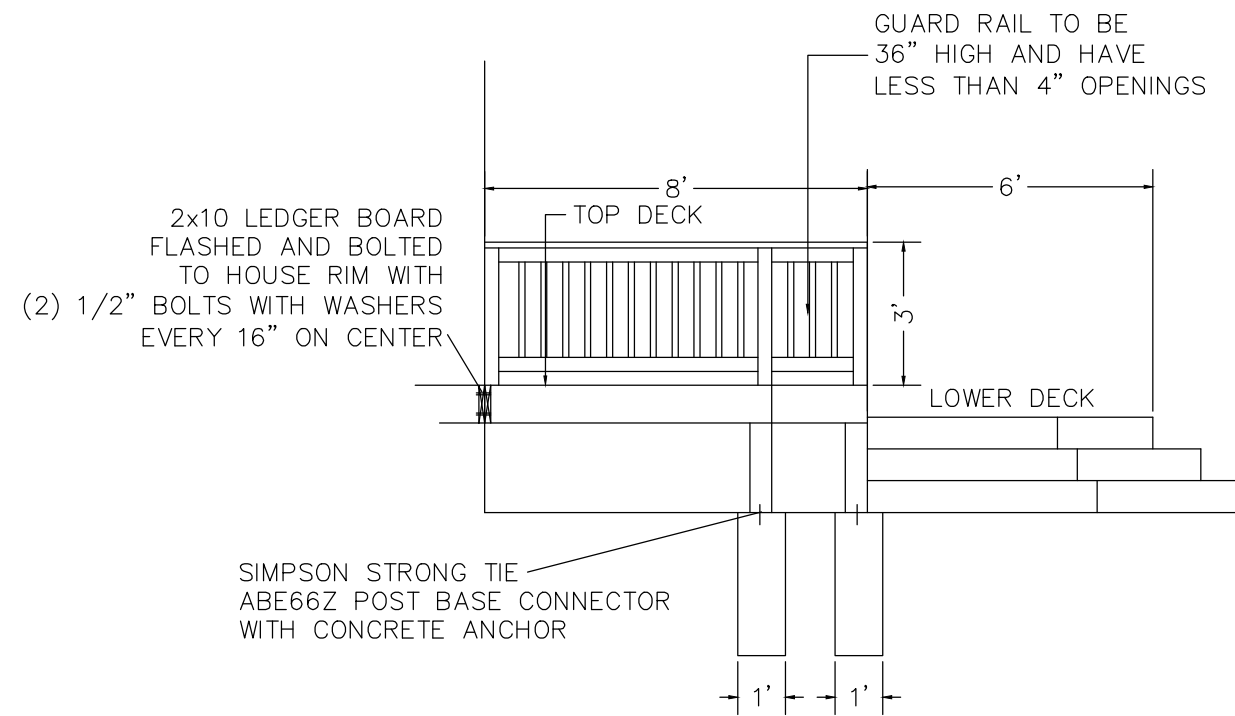

LEDBER BOARD TO BE FLASHED AND BOLTED (2) 1/2" BOLTS WITH WASHERS OR EQUIVALENT FASTENERS _____" O.C. (SEE LEDGER DETAIL IN DECK CONSTRUCTION GUIDE)

JOISTS TO BE 2x10 SOUTHERN YELLOW PINE TREATED 16" ON CENTER

BEAMS TO BE 2-2x10 SOUTHERN YELLOW PINE TREATED NAILED

RAILS TO BE 36" HIGH WITH LESS THAN 4" OPENINGS PER IRC CODE (see rail detail)

STAIRS TO BE BUILT MAX RISE 7 3/4" MIN RISE 4" PER IRC CODE (see detail)

DECKING TO BE _____ (FOLLOW MANUFACTURERS INSTALLATION INSTRUCTIONS)

ALL JOIST HANGERS TO BE CORROSION RESISTANT AND INSTALLED PER MANUFACTURERS INSTRUCTIONS

SIDE ELEVATION

4

DECK PLAN 2L084
REVERSE

	12" DIAMETER FOOTING	FOOTINGS TO BE INSTALLED TO PROPER DEPTH AS IS REQUIRED BY YOUR LOCAL BUILDING ORDINANCE
	16" DIAMETER FOOTING	FROST FOOTINGS SIZES BASED ON 55 LB PER SQUARE FOOT TRIBUTARY LOADS APPLIED TO 1500 PSI SOIL COMPRESSION CAPACITY (ASSUMED CLAY SOIL)
	22" DIAMETER FOOTING	SEE FOOTING DETAIL IN DECK CONSTRUCTION GUIDE.

DISCLAIMER: ONLY USE #2 OR BETTER PRESSURE TREATED SOUTHERN YELLOW PINE 2 x 10 FOR FRAMING MATERIALS NEVER SUBSTITUTE COMPOSITE OR SOFTWOODS FOR FRAMING MATERIALS

