



PERSPECTIVE

1

DECK PLAN 1PG1412

NAME

ADDRESS

PHONE



SCALE: 1/4" = 1' WHEN PRINTED ON 11x17 PAPER

BASED ON THE INTERNATIONAL RESIDENTIAL CODE

DISCLAIMER: THIS PLAN IS NOT CONSIDERED COMPLETE UNLESS APPROVED BY YOUR LOCAL BUILDING INSPECTOR OR STRUCTURAL ENGINEER. BUILDER ACCEPTS ALL RESPONSIBILITY AND LIABILITY. DECKS.COM LLC, AND ASSOCIATED SPONSORS ACCEPT NO LIABILITY FOR THE USE OF THIS PLAN.

STAIRWAY ILLUMINATION: ALL EXTERIOR STAIRWAYS SHALL BE ILLUMINATED AT THE TOP LANDING TO THE STAIRWAY. ILLUMINATION SHALL BE CONTROLLED FROM INSIDE THE DWELLING OR AUTOMATICALLY ACTIVATED.

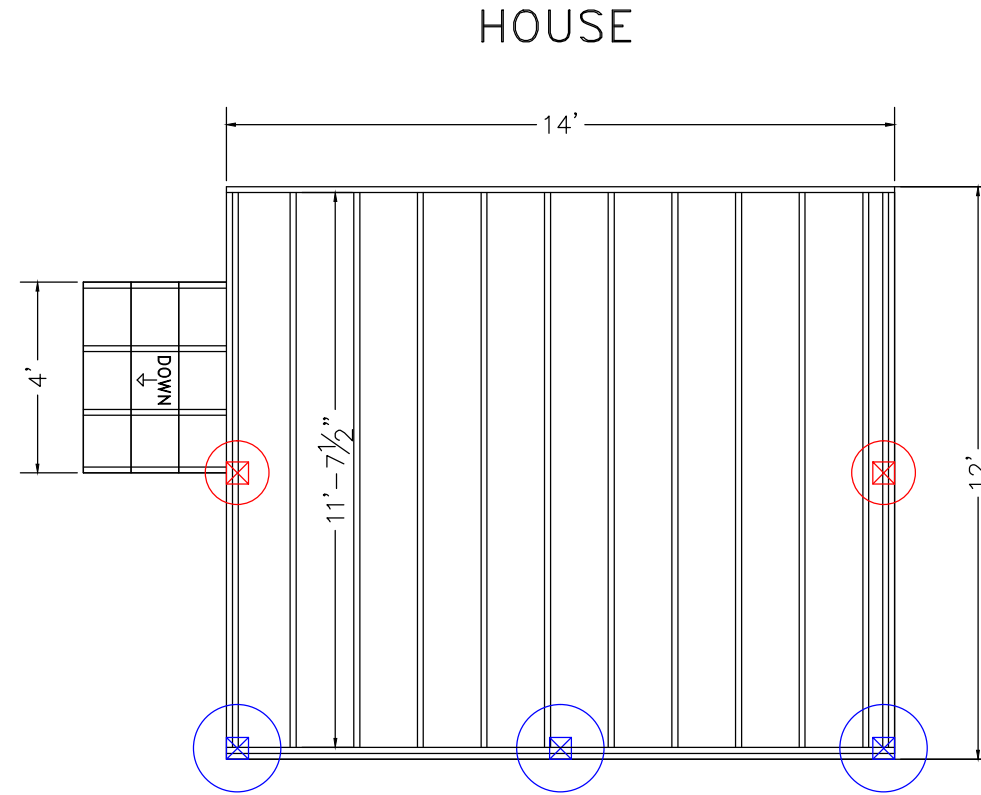

FOOTING SIZES ADJUSTED FOR ADDITIONAL 25 LBS PER SQUARE FOOT SNOW / ROOF LOAD

	12" DIAMETER FOOTING	FOOTINGS TO BE INSTALLED TO PROPER DEPTH AS IS REQUIRED BY YOUR LOCAL BUILDING ORDINANCE
	16" DIAMETER FOOTING	FROST FOOTINGS SIZES BASED ON 55 LB PER SQUARE FOOT TRIBUTARY LOADS APPLIED TO 1500 PSI SOIL COMPRESSION CAPACITY (ASSUMED CLAY SOIL)
	22" DIAMETER FOOTING	SEE FOOTING DETAIL IN DECK CONSTRUCTION GUIDE.

DISCLAIMER: ONLY USE #2 OR BETTER PRESSURE TREATED SOUTHERN YELLOW PINE 2 x 10 FOR FRAMING MATERIALS NEVER SUBSTITUTE COMPOSITE OR SOFTWOODS FOR FRAMING MATERIALS

LEDBER BOARD TO BE FLASHED AND BOLTED (2) 1/2" BOLTS WITH WASHERS OR EQUIVALENT FASTENERS _____" O.C. (SEE LEDGER DETAIL IN DECK CONSTRUCTION GUIDE)

JOISTS TO BE 2x10 SOUTHERN YELLOW PINE TREATED 16" ON CENTER
 BEAMS TO BE 2-2x10 SOUTHERN YELLOW PINE TREATED NAILED
 RAILS TO BE 36" HIGH WITH LESS THAN 4" OPENINGS PER IRC CODE (see rail detail)
 STAIRS TO BE BUILT MAX RISE 7 3/4" MIN RISE 4" MIN RUN 10" PER IRC CODE (see detail)
 DECKING TO BE _____ (FOLLOW MANUFACTURERS INSTALLATION INSTRUCTIONS)

ALL JOIST HANGERS TO BE CORROSION RESISTANT AND INSTALLED PER MANUFACTURERS INSTRUCTIONS



PLAN VIEW

2
 DECK PLAN 1PG1412

SCALE: 1/4" = 1' WHEN PRINTED ON 11x17 PAPER

BASED ON THE INTERNATIONAL RESIDENTIAL CODE

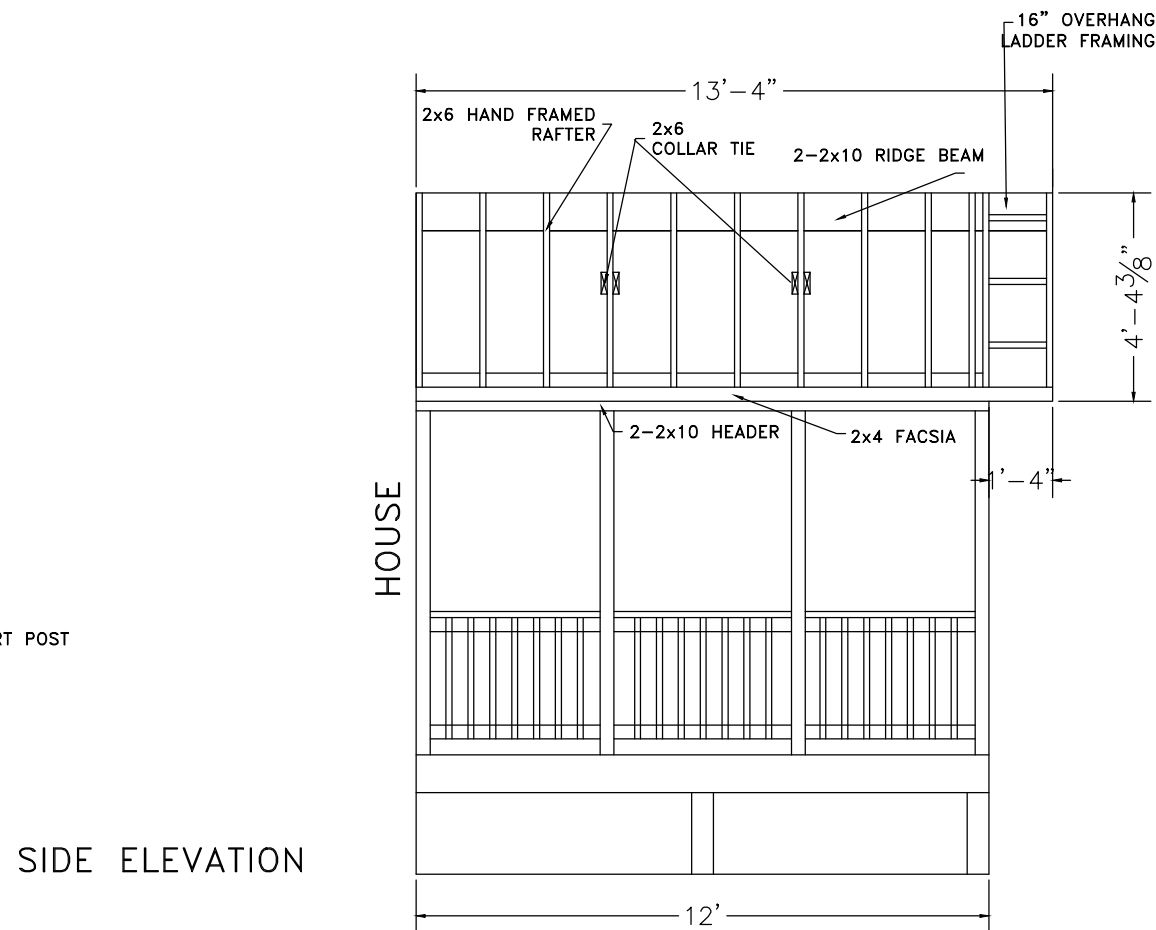
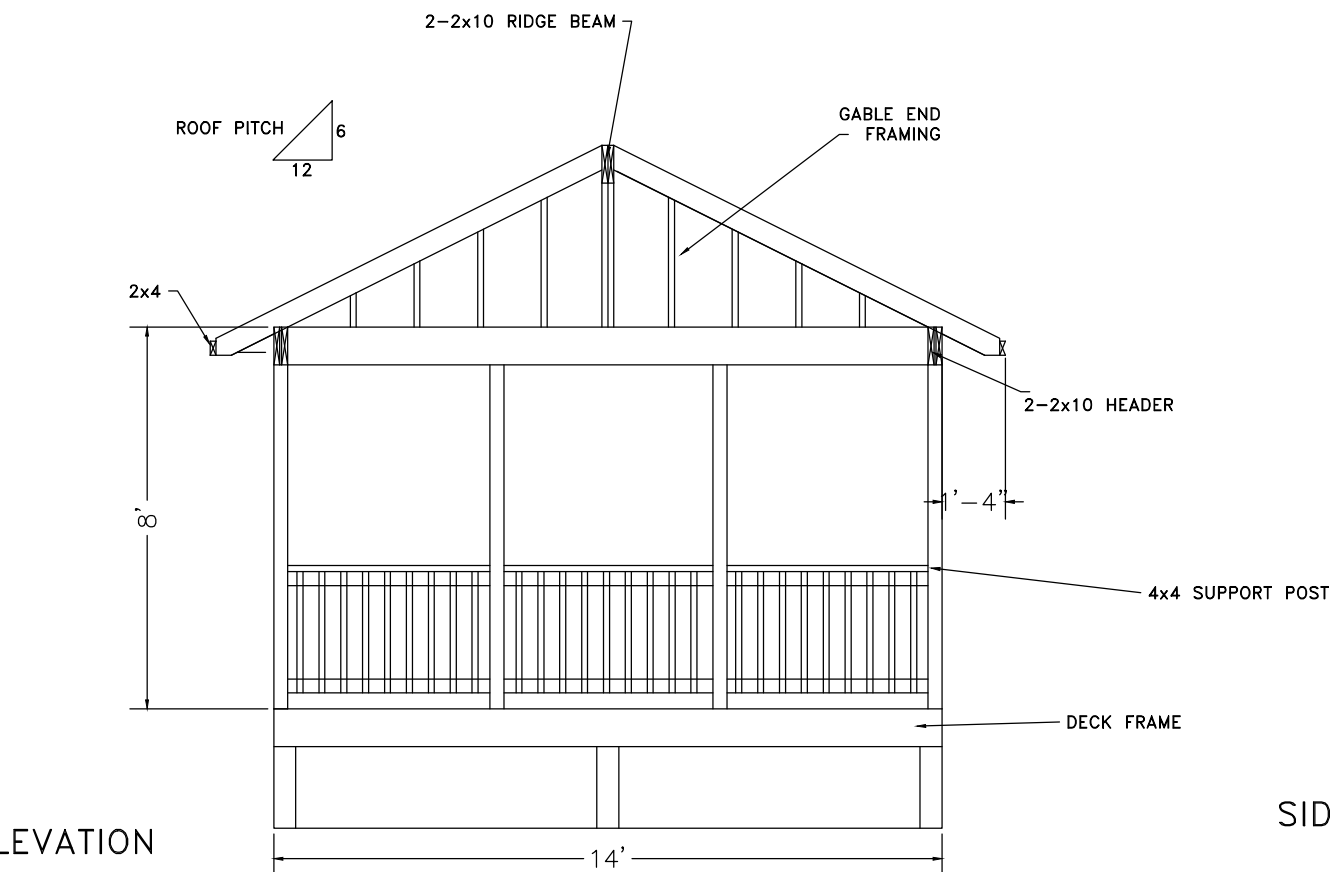
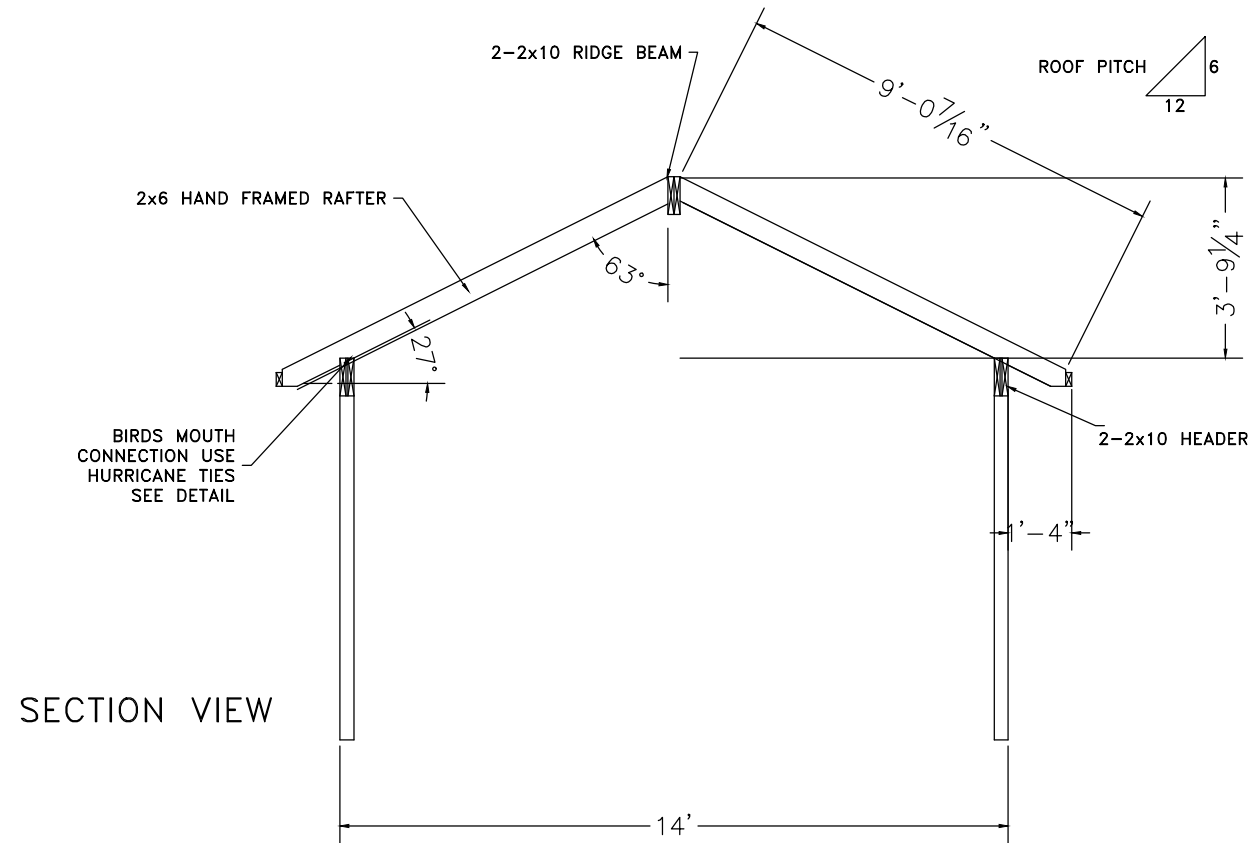
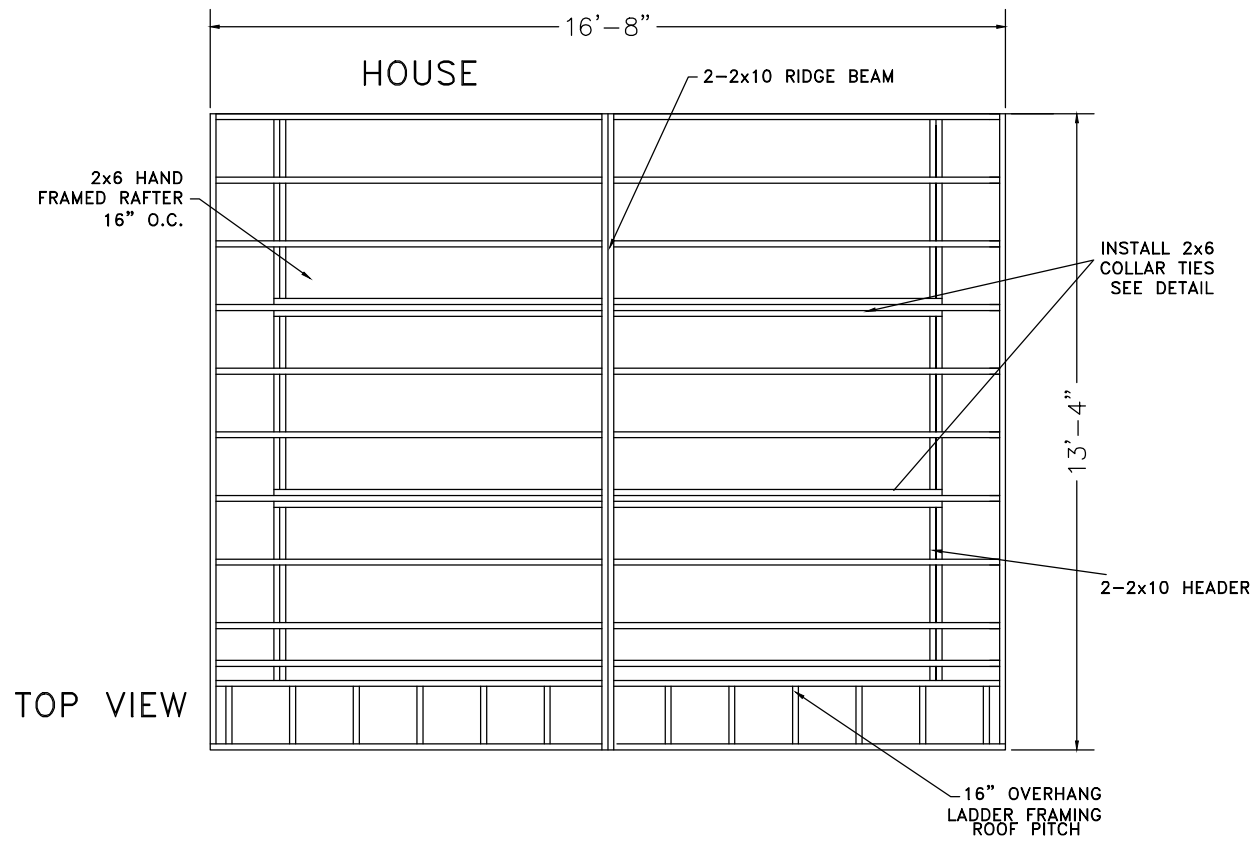

© DECKS.COM LLC

ROOF LAYOUT
DECK PLAN 1PG1412
3

STEP FLASH ROOF AT HOUSE CONNECTION
RAFTERS ARE TO BE HANDFRAMED 2x6 SPF 16" O.C. SPACING
RIDGE BEAM TO BE 2-2x10 SPF OR EQUIVALENT
SIDE HEADER BEAMS TO BE 2-2x10 SPF OR EQUIVALENT
RIDGE BEAM REQUIRES POSITIVE ATTACHMENT TO SOUND HOUSE FRAMING CAPABLE OF SUPPORTING ROOF LOAD
PORCH SUPPORTS TO BE 4x4 NOT SPACED GREATER THAN 5' APART
ROOF FRAME COVERED WITH 1/2" T&G PLYWOOD SUBROOF
ROOF FINISHED WITH ROOFING FELT AND 3-TAB ASPHALT SHINGLES OR EQUIVALENT
RAFTERS TO BE ATTACHED TO BEAMS USING HURRICANE TIE CONNECTORS



ROOF TO SUPPORT SNOW LOAD 25 LBS PER SQUARE FOOT
SEE TYPICAL PORCH HANDOUT FOR INSTALLATION DETAILS

DISCLAIMER: THIS PLAN IS NOT CONSIDERED COMPLETE UNLESS APPROVED BY YOUR LOCAL BUILDING INSPECTOR OR STRUCTURAL ENGINEER. BUILDER ACCEPTS ALL RESPONSIBILITY AND LIABILITY. DECKS.COM LLC, AND ASSOCIATED SPONSORS ACCEPT NO LIABILITY FOR THE USE OF THIS PLAN.

© DECKS.COM LLC

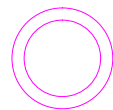
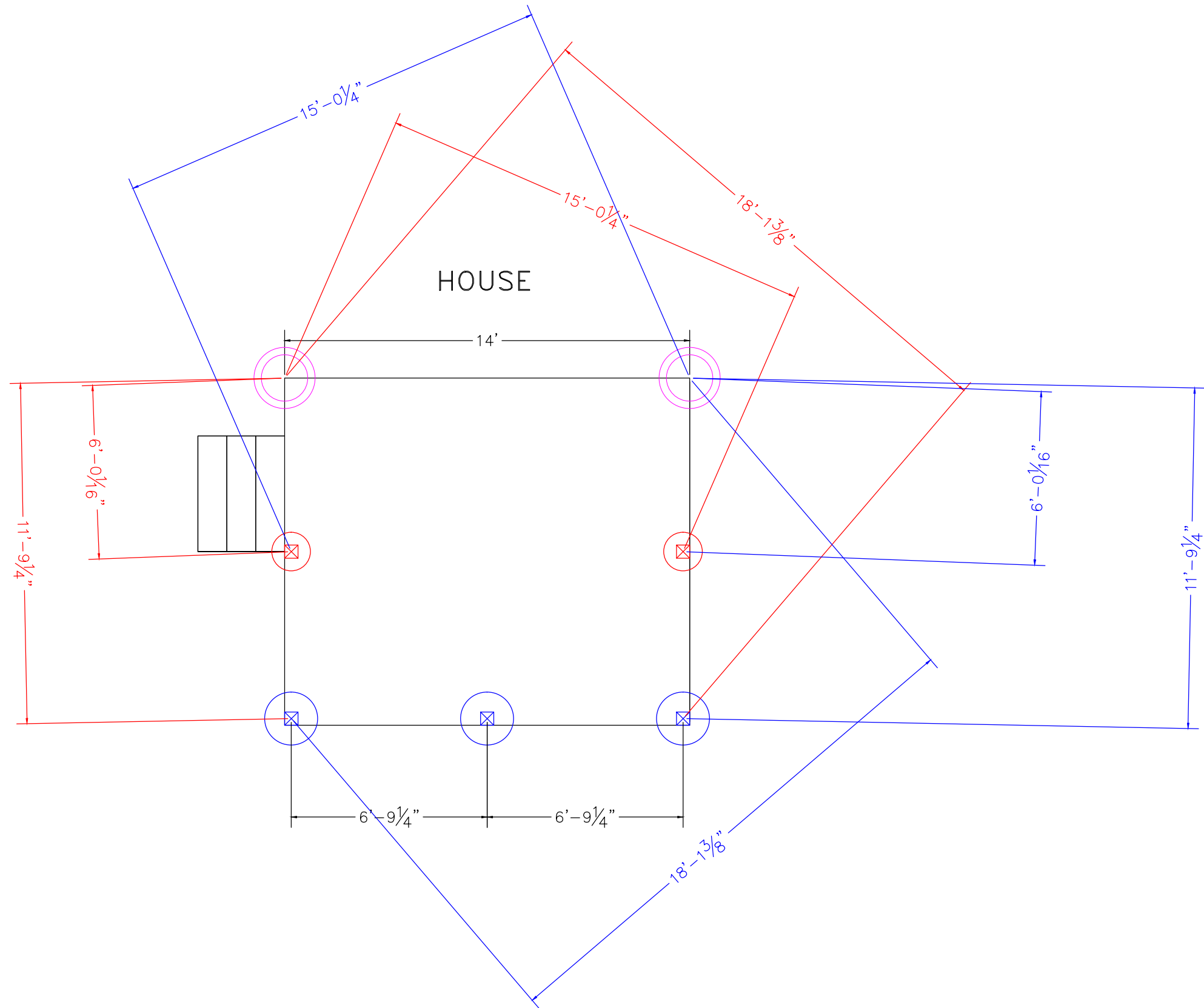

THIS IS A TRIANGULATION REFERENCE POINT
 MEASURE TO THE CENTER OF YOUR FOOTINGS
 FROM THESE POINTS. REFERENCE WWW.DECKS.COM/DECKBUILDING
 FOR MORE INFORMATION

DISCLAIMER: USE ONLY 2,500 PSI CONCRETE
 FOR FROST FOOTING FOUNDATIONS



12" DIAMETER FOOTING



16" DIAMETER FOOTING



22" DIAMETER FOOTING



FOOTINGS TO BE INSTALLED TO PROPER DEPTH AS IS REQUIRED BY YOUR LOCAL BUILDING ORDINANCE
 FROST FOOTINGS SIZES BASED ON 55 LB PER SQUARE FOOT TRIBUTARY LOADS APPLIED TO 1500 PSI SOIL COMPRESSION CAPACITY (ASSUMED CLAY SOIL)
 SEE FOOTING DETAIL IN DECK CONSTRUCTION GUIDE

FOOTING LAYOUT