



PERSPECTIVE

1

DECK PLAN 1PG1414

NAME

ADDRESS

PHONE



SCALE: 1/4" = 1' WHEN PRINTED ON 11x17 PAPER

BASED ON THE INTERNATIONAL RESIDENTIAL CODE

DISCLAIMER: THIS PLAN IS NOT CONSIDERED COMPLETE UNLESS APPROVED BY YOUR LOCAL BUILDING INSPECTOR OR STRUCTURAL ENGINEER. BUILDER ACCEPTS ALL RESPONSIBILITY AND LIABILITY. DECKS.COM LLC, AND ASSOCIATED SPONSORS ACCEPT NO LIABILITY FOR THE USE OF THIS PLAN.

STAIRWAY ILLUMINATION: ALL EXTERIOR STAIRWAYS SHALL BE ILLUMINATED AT THE TOP LANDING TO THE STAIRWAY. ILLUMINATION SHALL BE CONTROLLED FROM INSIDE THE DWELLING OR AUTOMATICALLY ACTIVATED.

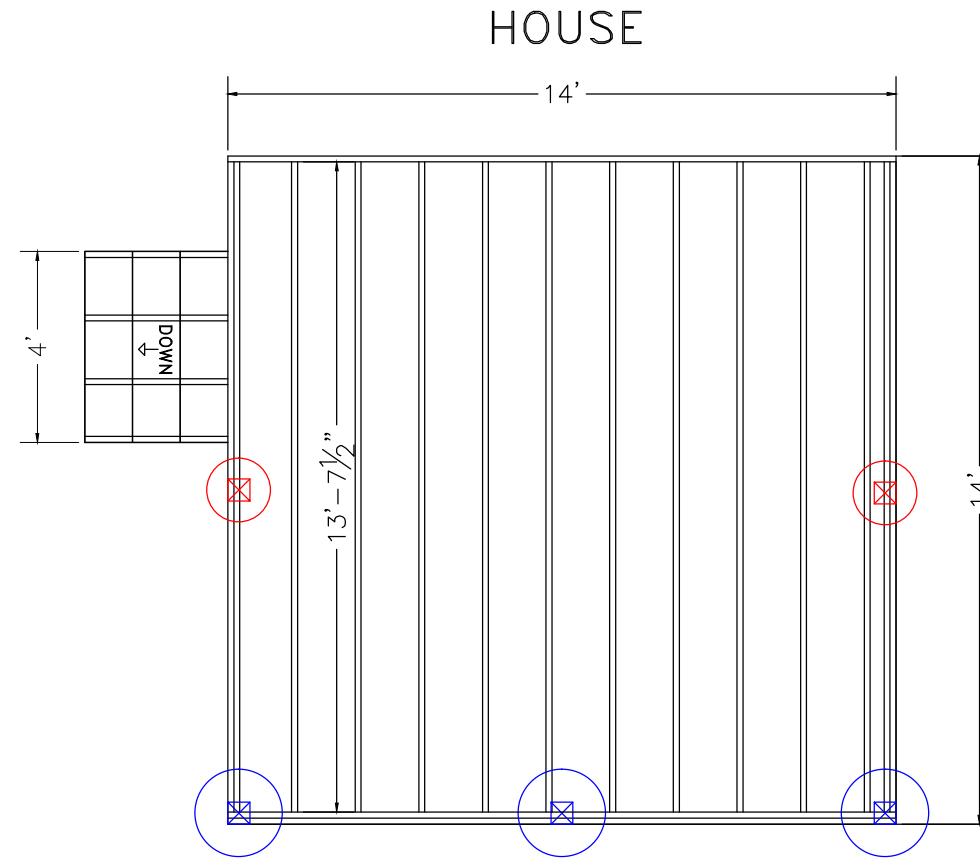

FOOTING SIZES ADJUSTED FOR ADDITIONAL 25 LBS PER SQUARE FOOT SNOW / ROOF LOAD

	12" DIAMETER FOOTING	FOOTINGS TO BE INSTALLED TO PROPER DEPTH AS IS REQUIRED BY YOUR LOCAL BUILDING ORDINANCE
	16" DIAMETER FOOTING	FROST FOOTINGS SIZES BASED ON 55 LB PER SQUARE FOOT TRIBUTARY LOADS APPLIED TO 1500 PSI SOIL COMPRESSION CAPACITY (ASSUMED CLAY SOIL)
	22" DIAMETER FOOTING	SEE FOOTING DETAIL IN DECK CONSTRUCTION GUIDE.

DISCLAIMER: ONLY USE #2 OR BETTER PRESSURE TREATED SOUTHERN YELLOW PINE 2 x 10 FOR FRAMING MATERIALS NEVER SUBSTITUTE COMPOSITE OR SOFTWOODS FOR FRAMING MATERIALS

LEDBER BOARD TO BE FLASHED AND BOLTED (2) 1/2" BOLTS WITH WASHERS OR EQUIVALENT FASTENERS \_\_\_\_\_" O.C. (SEE LEDGER DETAIL IN DECK CONSTRUCTION GUIDE)

JOISTS TO BE 2x10 SOUTHERN YELLOW PINE TREATED 16" ON CENTER BEAMS TO BE 2-2x10 SOUTHERN YELLOW PINE TREATED NAILED RAILS TO BE 36" HIGH WITH LESS THAN 4" OPENINGS PER IRC CODE (see rail detail) STAIRS TO BE BUILT MAX RISE 7 3/4" MIN RISE 4" MIN RUN 10" PER IRC CODE (see detail) DECKING TO BE \_\_\_\_\_ (FOLLOW MANUFACTURERS INSTALLATION INSTRUCTIONS)

ALL JOIST HANGERS TO BE CORROSION RESISTANT AND INSTALLED PER MANUFACTURERS INSTRUCTIONS



PLAN VIEW

2

DECK PLAN 1PG1414

SCALE: 1/4" = 1' WHEN PRINTED ON 11x17 PAPER

BASED ON THE INTERNATIONAL RESIDENTIAL CODE

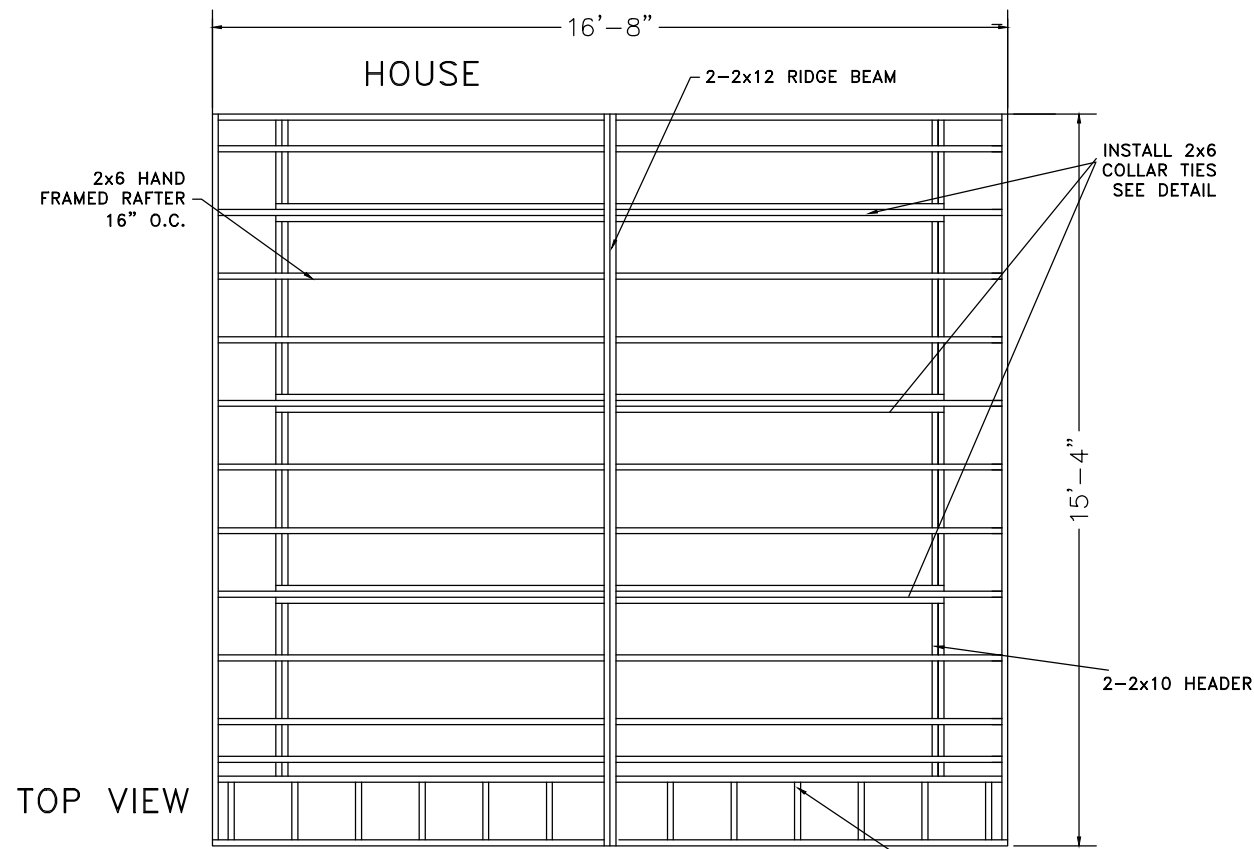

SECTION VIEW

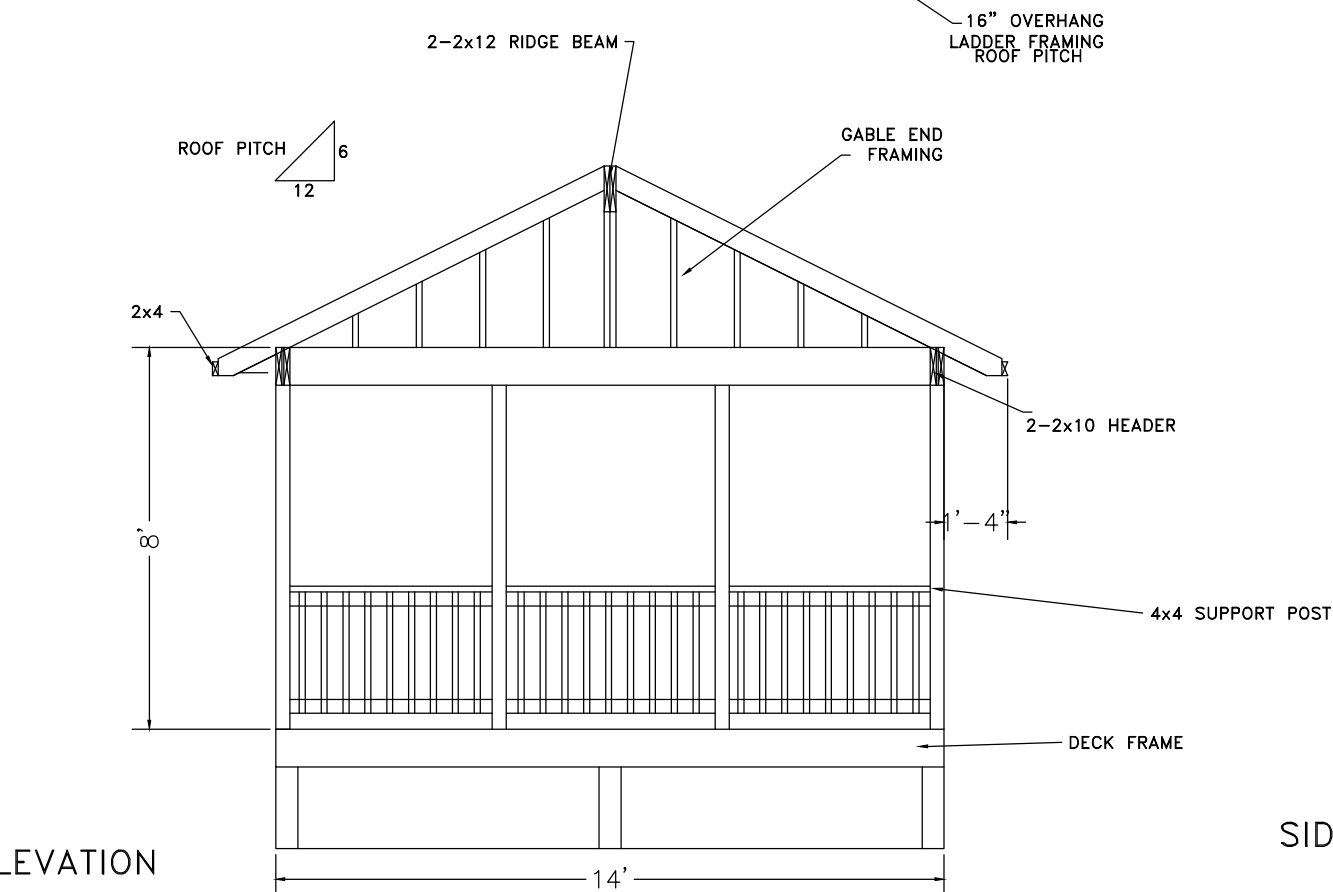
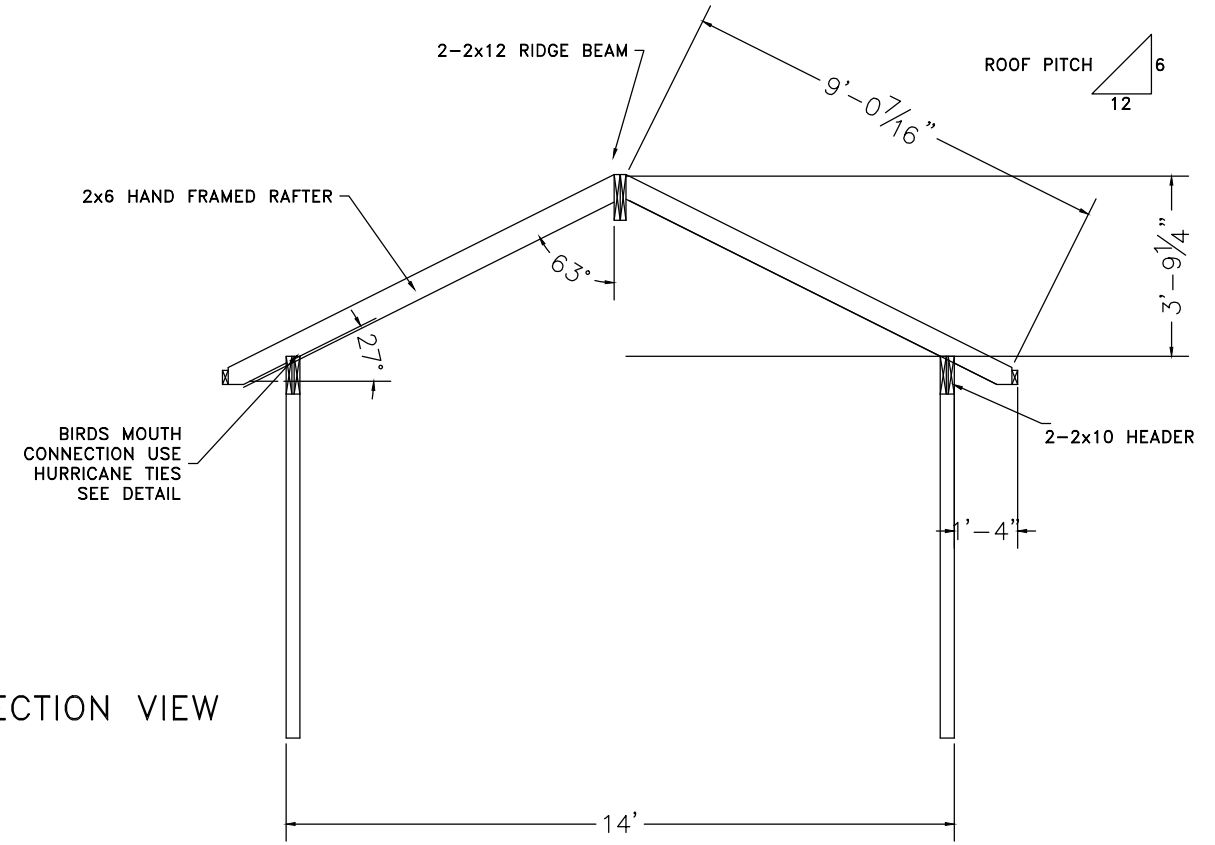

SIDE ELEVATION

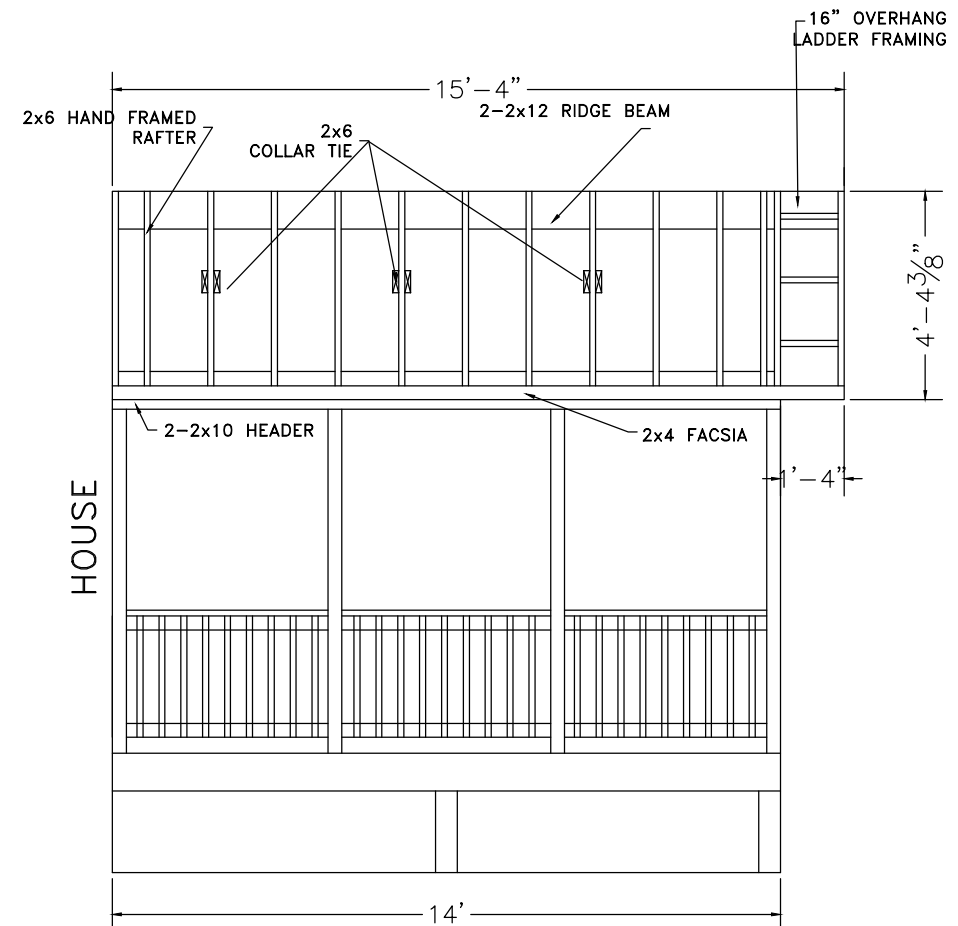

ROOF TO SUPPORT SNOW LOAD 25 LBS PER SQUARE FOOT  
SEE TYPICAL PORCH HANDOUT FOR INSTALLATION DETAILS

© DECKS.COM LLC

ROOF LAYOUT

3

DECK PLAN 1PG1414

STEP FLASH ROOF AT HOUSE CONNECTION  
 RAFTERS ARE TO BE HANDFRAMED 2x6 SPF 16" O.C. SPACING  
 RIDGE BEAM TO BE 2-2x10 SPF OR EQUIVALENT  
 SIDE HEADER BEAMS TO BE 2-2x10 SPF OR EQUIVALENT  
 RIDGE BEAM REQUIRES POSITIVE ATTACHMENT TO SOUND HOUSE FRAMING CAPABLE  
 OF SUPPORTING ROOF LOAD  
 PORCH SUPPORTS TO BE 4x4 NOT SPACED GREATER THAN 5' APART  
 ROOF FRAME COVERED WITH 1/2" T&G PLYWOOD SUBROOF  
 ROOF FINISHED WITH ROOFING FELT AND 3-TAB ASPHALT SHINGLES OR EQUIVALENT  
 RAFTERS TO BE ATTACHED TO BEAMS USING HURRICANE TIE CONNECTORS



© DECKS.COM LLC

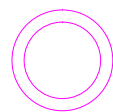
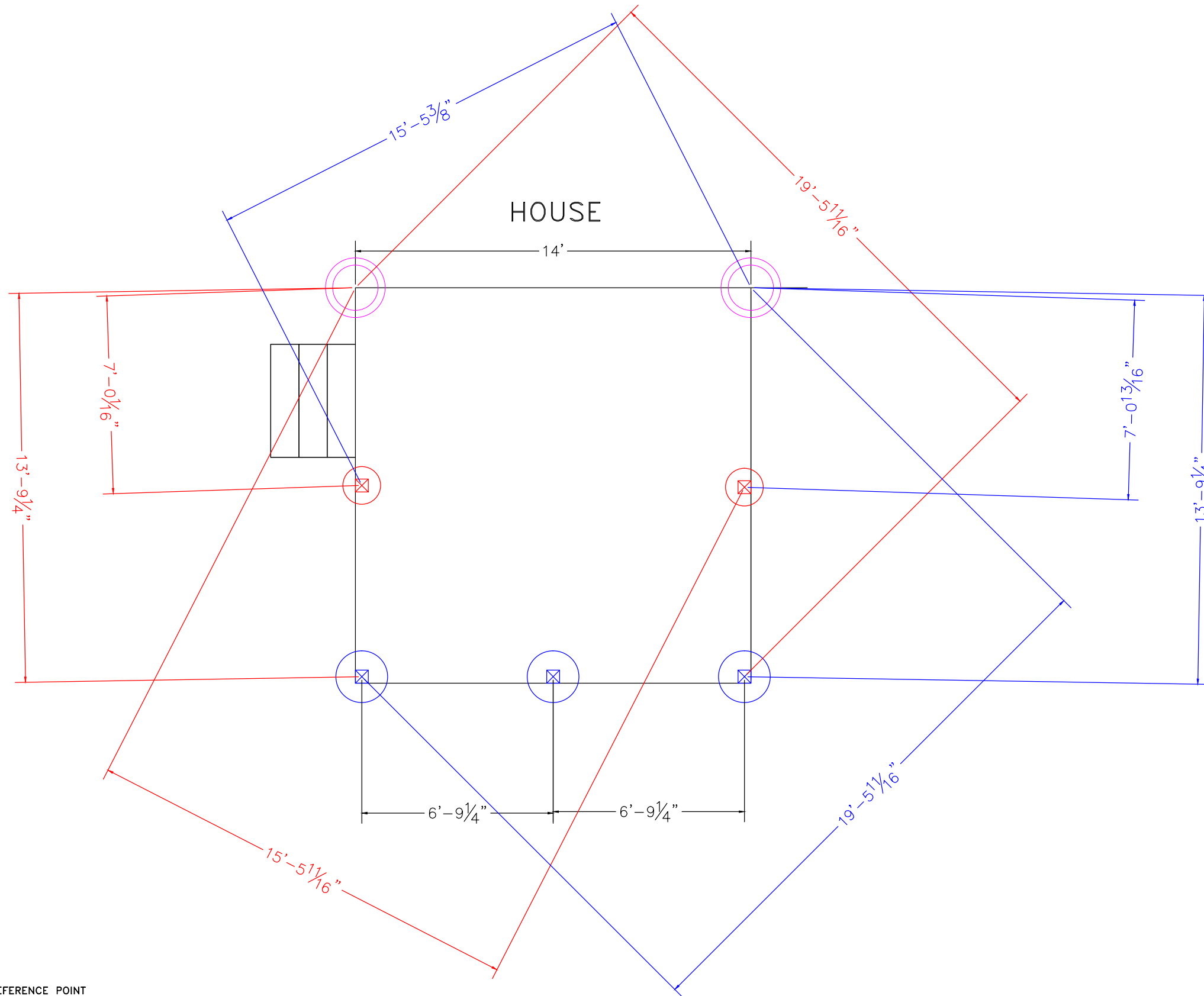

DISCLAIMER: THIS PLAN IS NOT CONSIDERED COMPLETE UNLESS APPROVED BY YOUR LOCAL BUILDING INSPECTOR OR STRUCTURAL ENGINEER. BUILDER ACCEPTS ALL RESPONSIBILITY AND LIABILITY. DECKS.COM LLC, AND ASSOCIATED SPONSORS ACCEPT NO LIABILITY FOR THE USE OF THIS PLAN.

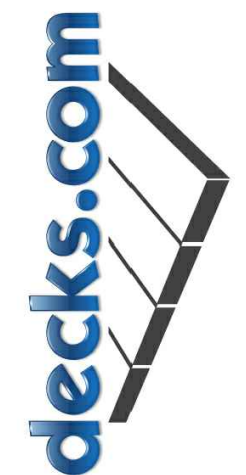

THIS IS A TRIANGULATION REFERENCE POINT  
 MEASURE TO THE CENTER OF YOUR FOOTINGS  
 FROM THESE POINTS. REFERENCE [WWW.DECKS.COM/DECKBUILDING](http://WWW.DECKS.COM/DECKBUILDING)  
 FOR MORE INFORMATION

DISCLAIMER: USE ONLY 2,500 PSI CONCRETE  
 FOR FROST FOOTING FOUNDATIONS



-  12" DIAMETER FOOTING
-  16" DIAMETER FOOTING
-  22" DIAMETER FOOTING

FOOTINGS TO BE INSTALLED TO PROPER DEPTH, AS IS REQUIRED BY YOUR LOCAL BUILDING ORDINANCE  
 FROST FOOTINGS SIZES BASED ON 55 LB PER SQUARE FOOT TRIBUTARY LOADS APPLIED TO 1500 PSI SOIL COMPRESSION CAPACITY (ASSUMED CLAY SOIL)  
 SEE FOOTING DETAIL IN DECK CONSTRUCTION GUIDE